



TRIAYURVEDA™

Grab The Excellent

Business Opportunity

**TRIAYURVEDA HEALTHTRADE
PRIVATE LIMITED**



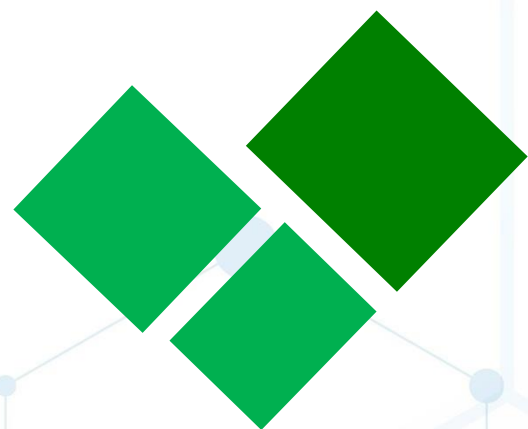

DISCLAIMER

Triayurveda Healthtrade Private Limited does not indulge in any kind of financial investment or cascade any investment scheme or chit fund entrepreneurship. Our company complies with the provision of the Consumer Protection (direct Selling) Rules, 2021 and is not involved in any Pyramid Scheme or Money Circulation Scheme.

<https://www.triayurveda.com>

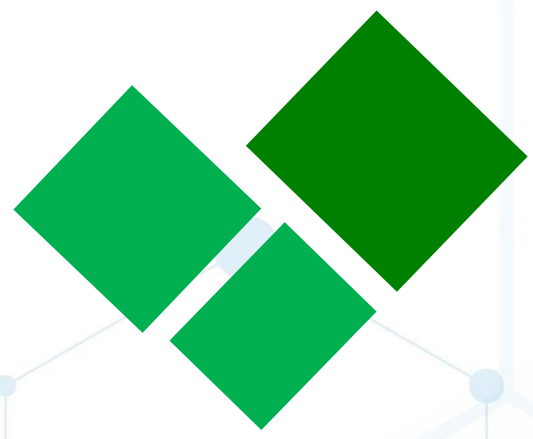

WHO WE ARE ?



Triayurveda is one of India's leading Direct Selling company which started its operation in year 2022. It offers a wide range of Ayurvedic & Herbal products to enable people to lead better lives. Our portfolio of high-quality, life-enhancing products have been developed exclusively for customers.

Our business model has motivated number of entrepreneurs across India. It provides E-Commerce portal to offer our products to customers and Direct Selling for IBO's known as Independent Business Owner's.



<https://www.triayurveda.com>

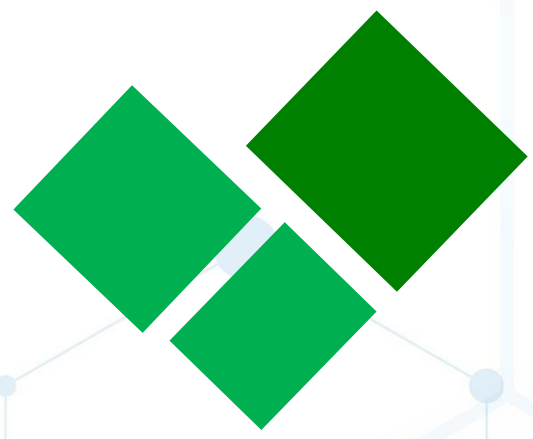

VISION & MISSION



VISION

To build a powerful society with extraordinary skills and wealth. Our culture is based on strong will and competitiveness, which is the foundation for constant innovation and high-quality Products that we offer.

MISSION

To become leading direct selling company in Health & Wellness industry. We want to achieve mutual success in the Indian market hand in hand with the IBO's. Trust is our commitment.



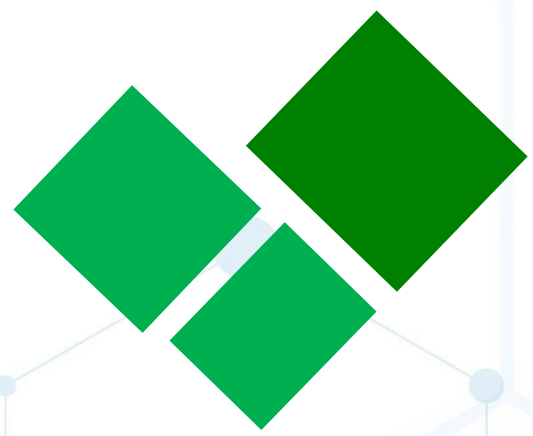

FROM DIRECTOR'S DESK



Triayurveda Healthtrade Private Limited appreciates all of you with humble regards.

As you know that the health sector is a billion dollar industry but health and wellness is a trillion dollar industry so we have established an unique project.

It is committed to maintain Healthy and Wealthy India, by introducing high quality Ayurvedic & Herbal (Medicinal & Nutritional) products along with **BUSINESS PLAN** for creating wealth in one's life to achieve financial freedom.

To stay Healthy, Wealthy & Happiness for a long life.

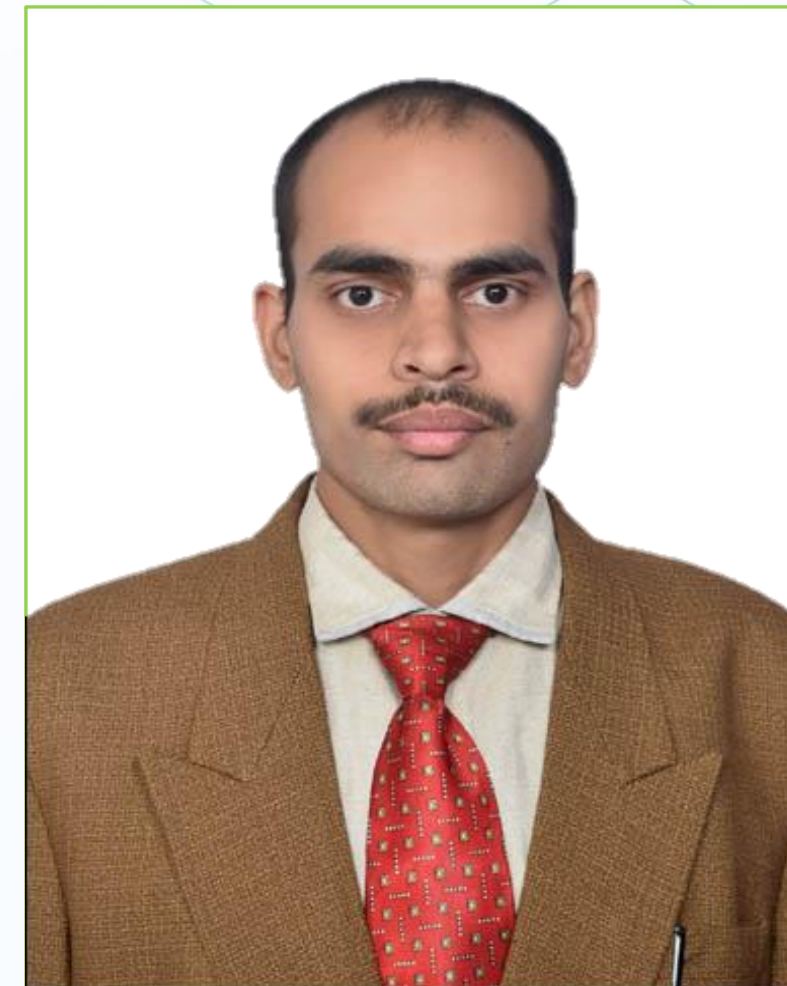

AMAN TRIVEDI

(CHIEF MANAGING DIRECTOR)
(Bachelor of Arts , Master of Arts)



PAWAN TRIVEDI

(CHIEF EXECUTIVE OFFICER)
(LL.B. (Hons.) , LL.M)

<https://www.triayurveda.com>

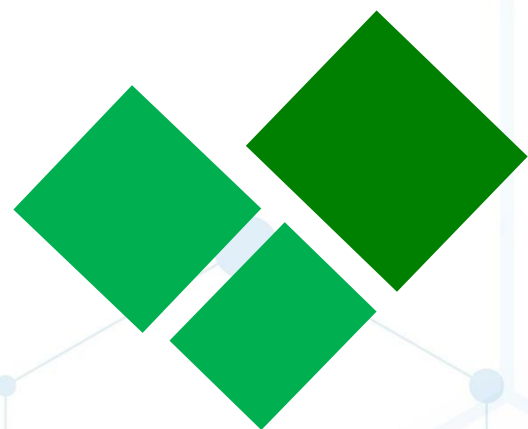

OUR LEGALS



सत्यमेव जयते
GOVERNMENT OF INDIA
MINISTRY OF CORPORATE AFFAIRS
Central Registration Centre

Certificate of Incorporation

[Pursuant to sub-section (2) of section 7 and sub-section (1) of section 8 of the Companies Act, 2013 (18 of 2013) and rule 18 of the Companies (Incorporation) Rules, 2014]

I hereby certify that TRIAYURVEDA HEALTHTRADE PRIVATE LIMITED is incorporated on this Eleventh day of October Two thousand twenty-two under the Companies Act, 2013 (18 of 2013) and that the company is limited by shares.

The Corporate Identity Number of the company is U52609UP2022PTC171964.

The Permanent Account Number (PAN) of the company is **AAJCT7233Q** *

The Tax Deduction and Collection Account Number (TAN) of the company is **LKNT07514D** *

Given under my hand at Manesar this Eleventh day of October Two thousand twenty-two .

MINISTRY OF CORPORATE AFFAIRS
Digital Signature Certificate
PANKAJ SRIVASTAVA
DEPUTY REGISTRAR OF COMPANIES
For and on behalf of the Jurisdictional Registrar of Companies
Registrar of Companies
Central Registration Centre

Disclaimer: This certificate only evidences incorporation of the company on the basis of documents and declarations of the applicant(s). This certificate is neither a license nor permission to conduct business or solicit deposits or funds from public. Permission of sector regulator is necessary wherever required. Registration status and other details of the company can be verified on www.mca.gov.in

Mailing Address as per record available in Registrar of Companies office:
TRIAYURVEDA HEALTHTRADE PRIVATE LIMITED
C/O BHOLA NATH, SHIV SHANKER, KALLI PASCHIM, UTRATIYA,
Lucknow, Uttar Pradesh, India, 226301



* as issued by the Income Tax Department

सत्यमेव जयते
Government of India
Form GST REG-06
[See Rule 10(1)]

Registration Certificate

Registration Number : 09AAJCT7233Q1ZI

1. Legal Name	TRIAYURVEDA HEALTHTRADE PRIVATE LIMITED		
2. Trade Name, if any	TRIAYURVEDA HEALTHTRADE PRIVATE LIMITED		
3. Additional trade names, if any	null		
4. Constitution of Business	Private Limited Company		
5. Address of Principal Place of Business	Kalli Pashchim Bazzar, 1, BHOLA NATH S/O SHIV SHANKAR, Raebareli Road, Kalli Pashchim, Lucknow, Lucknow, Uttar Pradesh, 226301		
6. Date of Liability			
7. Period of Validity	From	31/10/2022	To Not Applicable
8. Type of Registration	Regular		
9. Particulars of Approving Authority	Signature Not Valid Digitally signed by Sanjay KUMAR Tiwari, DN: cn=Sanjay KUMAR Tiwari, o=GOVERNMENT OF INDIA, ou=MINISTRY OF CORPORATE AFFAIRS, email=Sanjay.K.Tiwari@ca.mca.gov.in, c=IN Date: 2022.10.31 14:01:42 IST		
Name	Sanjay KUMAR Tiwari		
Designation	Superintendent		
Jurisdictional Office	Lucknow Sector- 12		
9. Date of issue of Certificate	31/10/2022		

Note: The registration certificate is required to be prominently displayed at all places of business in the State.

This is a system generated digitally signed Registration Certificate issued based on the approval of application granted on 31/10/2022 by the jurisdictional authority.

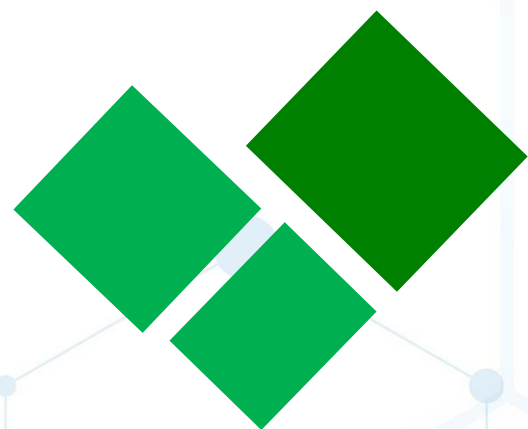

OUR LEGALS



TRIAYURVEDA™



आयकर विभाग
INCOME TAX DEPARTMENT

भारत सरकार
GOVT. OF INDIA

ई- स्थायी लेखा संख्या कार्ड
e - Permanent Account Number (e-PAN) Card
AAJCT7233Q

नाम / Name	TRIAYURVEDA HEALTHRADE PRIVATE LIMITED
निगमन/गठन की तारीख Date of Incorporation / Formation	11/10/2022
	

✓ Permanent Account Number (PAN) facilitate Income Tax Department linking of various documents, including payment of taxes, assessment, tax demand tax arrears, matching of information and easy maintenance & retrieval of electronic information etc. relating to a taxpayer.
 स्थायी लेखा संख्या (पैन) एक कर्दादा से संबंधित विभिन्न दस्तावेजों को जोड़ने में आयकर विभाग को सहायक होता है, जिसमें करों के भुगतान, आकलन, कर मांग, टैक्स बकाया, सूचना के मिलान और इलेक्ट्रॉनिक जानकारी का आसान खरखाब व बहाली आदि भी शामिल है।

✓ Quoting of PAN is now mandatory for several transactions specified under Income Tax Act, 1961 (Refer Rule 114B of Income Tax Rules, 1962) आयकर अधिनियम, 1961 के तहत निर्दिष्ट कई लेनदेन के लिए स्थायी लेखा संख्या (पैन) का उल्लेख अब अनिवार्य है। (आयकर नियम, 1962 के नियम 114B, का संदर्भ लें)

✓ Possessing or using more than one PAN is against the law & may attract penalty of upto Rs. 10,000.
एक से अधिक स्थायी लेखा संख्या (पैन) का रखना या उपयोग करना, कानून के विरुद्ध है और इसके लिए, 10,000 रुपये तक का दंड लगाया जा सकता है।

✓ The PAN Card enclosed contains Enhanced QR Code which is readable by a specific Android Mobile App. Keyword to search this specific Mobile App on Google Play Store is "Enhanced QR Code Reader for PAN Card".
संलग्न पैन कार्ड में एनहांसड क्यूआर कोड शामिल है जो एक विशिष्ट एंड्रॉइड मोबाइल ऐप द्वारा पठनीय है। Google Play Store पर इस विशिष्ट मोबाइल ऐप को खोजने के लिए कीवर्ड "Enhanced QR Code Reader for PAN Card" है।

आयकर विभाग
INCOME TAX DEPARTMENT

भारत सरकार
GOVT. OF INDIA

स्थायी लेखा संख्या कार्ड
Permanent Account Number Card
AAJCT7233Q

नाम / Name
TRIAYURVEDA HEALTHRADE PRIVATE LIMITED

निगमन/गठन की तारीख
Date of Incorporation / Formation
11/10/2022

इस कार्ड के खोने/पाने पर कृपया सूचित करें/सूचित करें:
आयकर पैन सेवा कार्ड, पर एन टी सी
5 वीं मंजिल, सीडी ब्लॉक,
फ्लोर नं. 341, एन 1, 997/8,
मॉडल कॉलोनी, नर देव बंगला चौक के पास,
पुणे - 411 016.

If this card is lost / someone's lost card is found,
please inform / returns to:
Income Tax PAN Services Unit, NSDL
5th Floor, Mantri Sterling,
Plot No. 341, Survey No. 997/8,
Model Colony, Near Deep Bungalow Chowk,
Pune - 411 016.

Tel: 91-20-2721 8080, Fax: 91-20-2721 8081
e-mail: tininfo@nsdl.co.in



Electronically issued and Digitally signed ePAN is a valid mode of issue of Permanent Account Number (PAN) post amendments in clause (c) in the Explanation occurring after sub-section (8) of Section 139A of Income Tax Act, 1961 and sub-rule (6) of Rule 114 of the Income Tax Rules, 1962. For further details, [click here](https://www.triayurveda.com)



आयकर विभाग
INCOME TAX DEPARTMENT

भारत सरकार
GOVT. OF INDIA

Ref.No.: 88305920095223/TAN/NEW

TO,
TRIAYURVEDA HEALTHRADE PRIVATE LIMITED
C/O BHOLA NATH, SHIV SHAN
KALI PASCHIM
KEER
UTTARIYA, LUCKNOW-226301
TELE. NO.:7457991999

Sir/Madam,

Sub : Allotment of Tax Deduction Account Number (TAN) as per Income Tax Act, 1961.
Kindly refer to your application (Form 49B) dated Oct 11, 2022 for the allotment of Tax Deduction Account Number.

In this connection, the following TAN has been issued to you/your organisation:
LKNT07514D

Please quote the same in all TDS challans, TDS Certificates, TDS returns, Tax Collection at Source (TCS) returns as well as other documents pertaining to such transactions.

Quoting of TAN on all TDS returns and challans for payment of TDS is necessary to ensure credit of TDS paid by you and faster processing of TDS returns.

The above TAN should also be used as Tax Collections at Source Account Number under section 206CA.

Kindly note that it is mandatory to quote TAN while furnishing TDS returns, including e-TDS returns. e-TDS returns will not be accepted if TAN is not quoted.

This supersedes all the Tax Deduction / Collection Account Number, allotted to you earlier.

Income Tax Department

Caution : Income Tax Department does not send e-mails regarding refunds and does not seek any taxpayer information like username, password, details of ATM, bank accounts, credit cards, etc. Taxpayers are advised not to part with such information on the basis of emails.

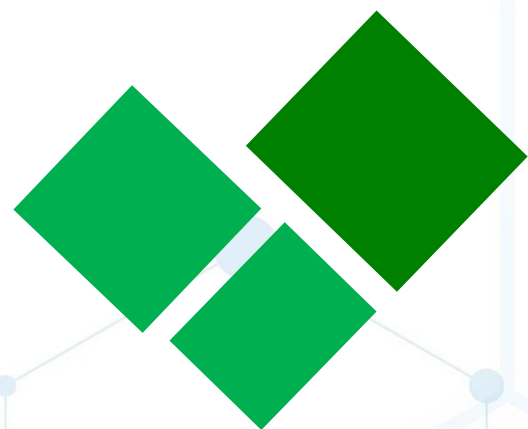

OUR LEGALS



INTERNATIONAL MANAGEMENT CERTIFICATION
IMC

Certificate of Registration

This is to certify that

TRIAYURVEDA HEALTHTRADE PRIVATE LIMITED
C/O BHOLA NATH, SHIV SHANKER, KALLI PASCHIM, UTRATIYA, LUCKNOW,
UTTAR PRADESH, INDIA, PIN CODE- 226301

has been independently assessed by IMC and is compliance with the requirement of the standard

ISO 9001:2015
Quality Management System

For the following scope of activities
AYURVEDA & HEALTHCARE

Certificate Number: QMS-THEL-22-0812132
To verify this certificate please visit at gaafs.us

Date of Certification	08-Nov-2022
Issuance Date	08-Nov-2022
1st Surveillance Due	07-Nov-2023
2nd Surveillance Due	07-Nov-2024
Re-Certificate Due	07-Nov-2025

Authorized Signatory

Validity of this Certificate is subject to annual Surveillance audits done successfully
This certificate remain the property of IMC and must be returned whenever demanded IMC is an independent system product and personal assessment body IMC is accredited by Globle Accreditation Assessment Forum Series (GAAFS)

CERTIFICATE ■ CERTIFICADO ■ CERTIFICATO ■ ZERTIFIKAT ■

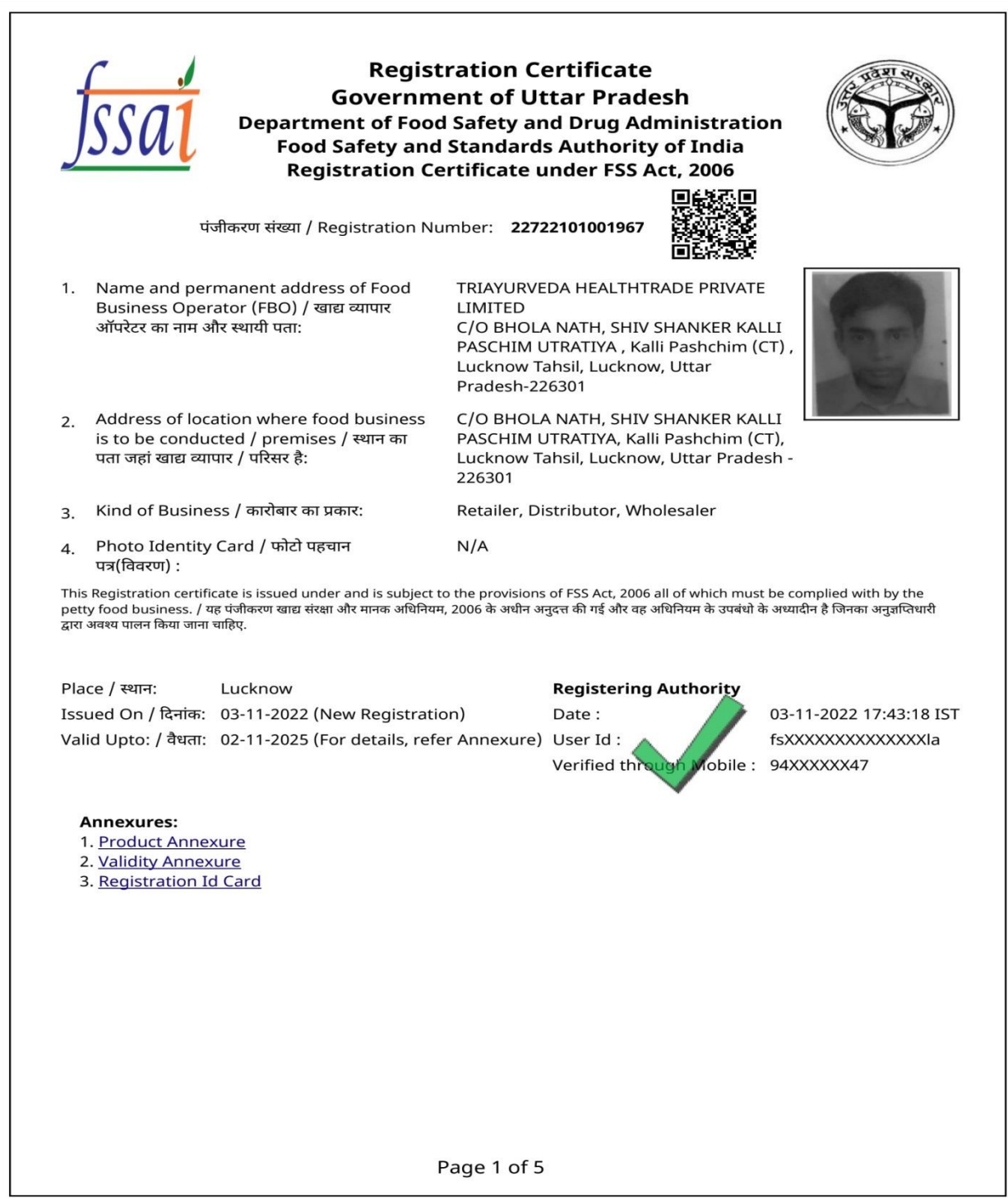

fssai **Registration Certificate**
Government of Uttar Pradesh
Department of Food Safety and Drug Administration
Food Safety and Standards Authority of India
Registration Certificate under FSS Act, 2006

पंजीकरण संख्या / Registration Number: **22722101001967**

1. Name and permanent address of Food Business Operator (FBO) / खाद्य व्यापार ऑपरेटर का नाम और स्थायी पता: TRIAYURVEDA HEALTHTRADE PRIVATE LIMITED
C/O BHOLA NATH, SHIV SHANKER KALLI PASCHIM UTRATIYA , Kalli Pashchim (CT) , Lucknow Tahsil, Lucknow, Uttar Pradesh-226301

2. Address of location where food business is to be conducted / premises / स्थान का पता जहां खाद्य व्यापार / परिसर है: C/O BHOLA NATH, SHIV SHANKER KALLI PASCHIM UTRATIYA, Kalli Pashchim (CT), Lucknow Tahsil, Lucknow, Uttar Pradesh - 226301

3. Kind of Business / कारोबार का प्रकार: Retailer, Distributor, Wholesaler

4. Photo Identity Card / फोटो पहचान पत्र(विवरण) : N/A

This Registration certificate is issued under and is subject to the provisions of FSS Act, 2006 all of which must be complied with by the petty food business. / यह पंजीकरण खाद्य संस्था और मानक अधिनियम, 2006 के अधीन अनुदत्त की गईं और वह अधिनियम के उपबंधों के अध्यादीन हे जिनका अनुसंधिचारी द्वारा अवश्य पालन किया जाना चाहिए.

Place / स्थान: Lucknow
Issued On / दिनांक: 03-11-2022 (New Registration)
Valid Upto: / वैधता: 02-11-2025 (For details, refer Annexure)

Registering Authority
Date : 03-11-2022 17:43:18 IST
User Id : fsXXXXXXXXXXXXXla
Verified through Mobile : 94XXXXXX47

Annexures:
1. [Product Annexure](#)
2. [Validity Annexure](#)
3. [Registration Id Card](#)

Page 1 of 5

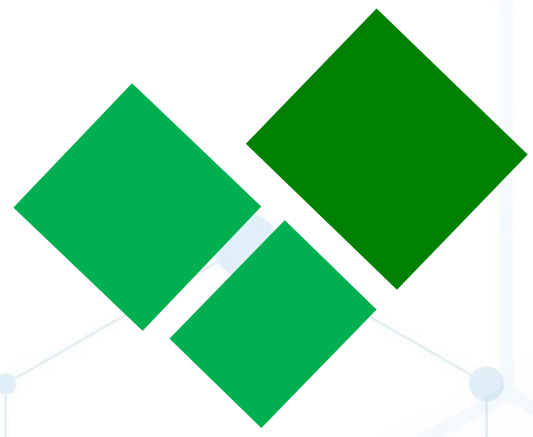

OUR LEGALS

11/22/22, 11:26 AM Print : Udyam Registration Certificate

भारत सरकार
Government of India
सूक्ष्म, लघु एवं मध्यम उद्यम मंत्रालय
Ministry of Micro, Small and Medium Enterprises

UDYAM REGISTRATION CERTIFICATE

UDYAM REGISTRATION NUMBER: UDYAM-UP-50-0067587

NAME OF ENTERPRISE: M/S TRIAYURVEDA HEALTHTRADE PRIVATE LIMITED

TYPE OF ENTERPRISE*: MICRO (Based on FY 2020-21)

MAJOR ACTIVITY: **TRADING**
[For availing benefits of Priority Sector Lending(PSL) ONLY]

SOCIAL CATEGORY OF ENTREPRENEUR: GENERAL

NAME OF UNIT(S):

S.No.	Name of Unit(s)		
1	M/S TRIAYURVEDA HEALTHTRADE PRIVATE LIMITED		

OFFICIAL ADDRESS OF ENTERPRISE:

Flat/Door/Block No.	1	Name of Premises/ Building	C/O BHOLA NATH, SHIV SHANKER
Village/Town	KALLI PASCHIM	Block	Sarojini nagar
Road/Street/Lane	KALLI PASCHIM BAZAR	City	LUCKNOW
State	UTTAR PRADESH	District	LUCKNOW , Pin 226301
Mobile	7457991999	Email:	aman1996trivedi@gmail.com

DATE OF INCORPORATION / REGISTRATION OF ENTERPRISE: 11/10/2022

DATE OF COMMENCEMENT OF PRODUCTION/BUSINESS: 11/10/2022

NATIONAL INDUSTRY CLASSIFICATION CODE(S):

SNo.	NIC 2 Digit	NIC 4 Digit	NIC 5 Digit	Activity
1	47 - Retail trade, except of motor vehicles and motorcycles	4772 - Retail sale of pharmaceutical and medical goods, cosmetic and toilet articles in specialized stores	47721 - Retail sale of pharmaceuticals, medical and orthopaedic goods and toilet articles	Trading

DATE OF UDYAM REGISTRATION: 15/11/2022

* In case of graduation (upward/reverse) of status of an enterprise, the benefit of the Government Schemes will be availed as per the provisions of Notification No. S.O. 2119(E) dated 26.06.2020 issued by the M/o MSME.
Disclaimer: This is computer generated statement, no signature required. Printed from <https://udyamregistration.gov.in> & Date of printing:- 22/11/2022

https://udyamregistration.gov.in/Udyam_User/Udyam_PrintApplication.aspx 1/4

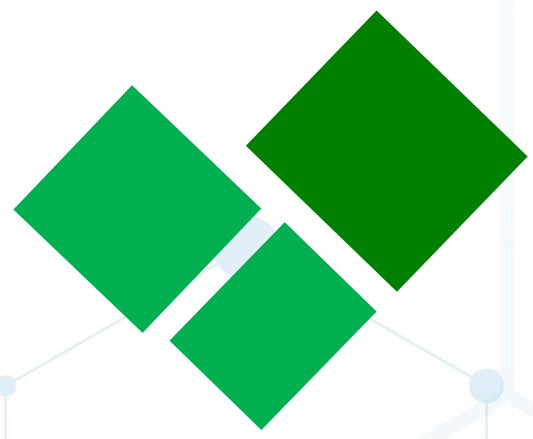

GRAB THE OPPORTUNITY AT TRIAYURVEDA



Registration

FREE

Indications-

- 1. IBO (Independent Business Owner)**
- 2. MRP (Maximum Retail Price)**
- 3. DP (Discount Price)**
- 4. BC (Business Center)**
- 5. BV (Business Volume)**
1 BV = Rs. 1/-

<https://www.triayurveda.com>

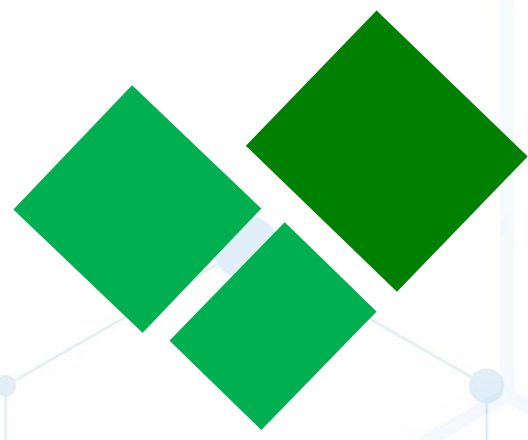

GROUP OF PRODUCTS



MRP – 20000/-
DP – 10000/-
BV – 5000
BONUS – 400

Per day Capping
Rs. 60000 X 30 Days
= 18 Lac Per Month

1
MEGA

2
PREMIUM

MRP – 10000/-
DP – 5000/-
BV – 2500
BONUS – 200

Per day Capping
Rs. 30000 X 30 Days
= 9 Lac Per Month

3
BASIC

MRP – 5000/-
DP – 2500/-
BV – 1250
BONUS – 100

Per day Capping
Rs. 15000 X 30 Days
= 4.5 Lac Per Month

<https://www.triayurveda.com>

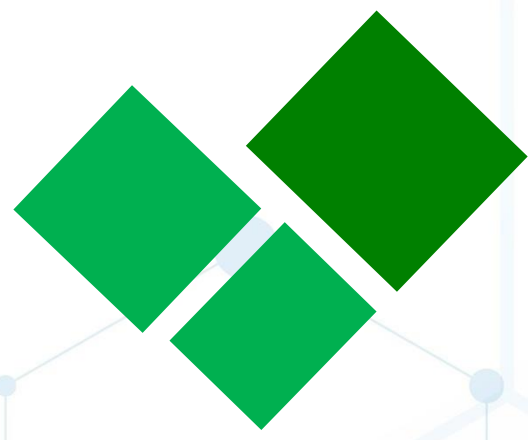

TYPE OF BONUS

1. Consumer Discount - Up to 60%

2. BC1 & BC2 Ratio Bonus – 10%

4. Infinity Bonus - 200, 100, 50

3. Sponsor's Ratio Bonus –100%

5. Sponsor's Infinity Bonus – 100%

i) Sponsor's Ratio Bonus – 50%

i) Sponsor's Infinity Bonus – 50%

Table (ii to vi) Distribution applicable for Sr. No. 3 & 5

ii) Royalty Bonus – 5%

iii) Car Bonus – 5%

iv) House Bonus – 5%

v) Tour & Travel Bonus – 5%

vi) Ranks/Rewards Bonus – 30%

6. Reurchase Ratio Bonus –10%

7. Franchise Bonus – 20%

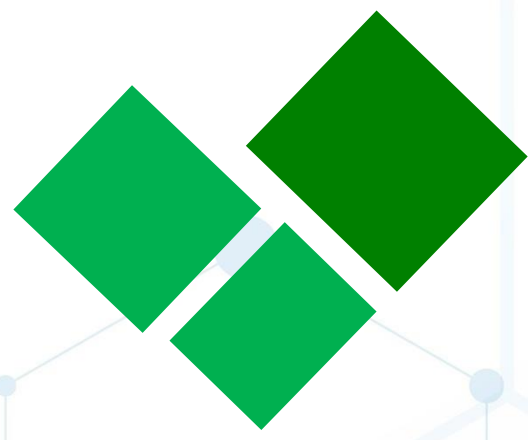

CONSUMER DISCOUNT



**UPTO
60%**

	MRP	-	DP	=	DISCOUNT
1.	700	-	300	=	400
2.	2500	-	1250	=	1250

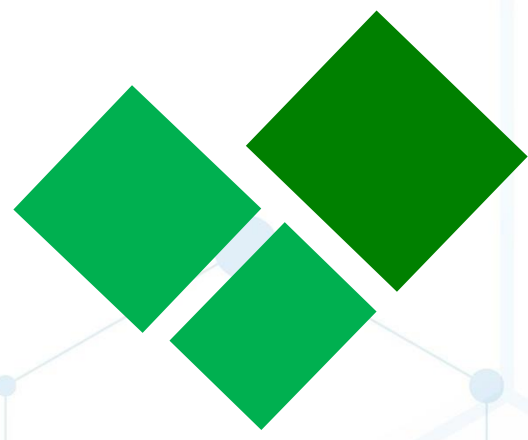

BC1 & BC2 RATIO BONUS – 10%



BC - 1

IBO 1

BV - 5000



YOU



BC - 2

IBO 2

BV - 5000 X 10% = 500/-

YOU

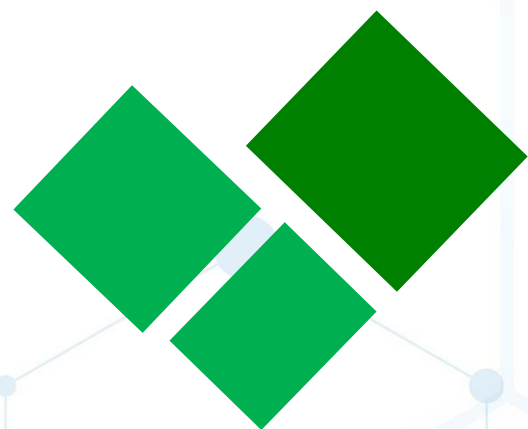

SPONSOR'S RATIO BONUS- 50%



$500 \times 50\% = 250/-$ $250/- = 50\% \times 500$



500/-
Total Sponsor's
Bonus

$500/- = \% 10 \times BV - 5000 : BV - 5000$

$BV - 5000 : BV - 5000 \times 10 \% = 500/-$

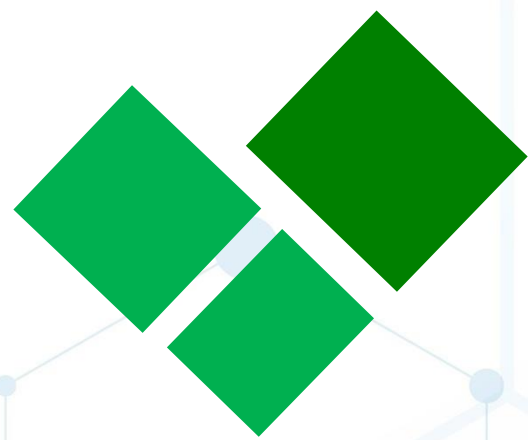

INFINITY BONUS- 200, 100, 50



$200 + 200 = 400/-$

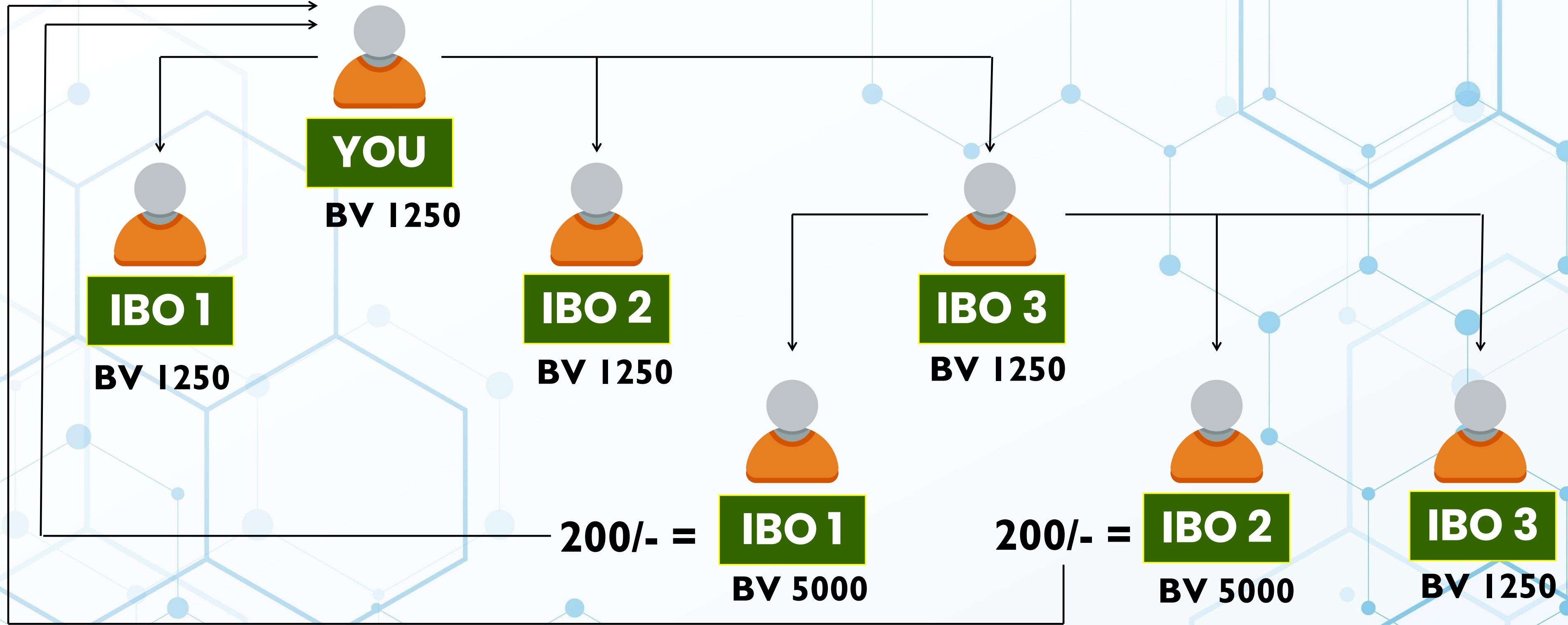

YOU

You will get 200/- from IBOs 3rd, IBO 1 & IBO 2, Total Infinity BONUS 400/-.
You will get Infinity BONUS from unlimited IBOs 3rd, IBO's 1 & IBO's 2, IBO 1 & IBO 2.
You Will get infinity bonus onwards like IBOs 3rd as shown above.

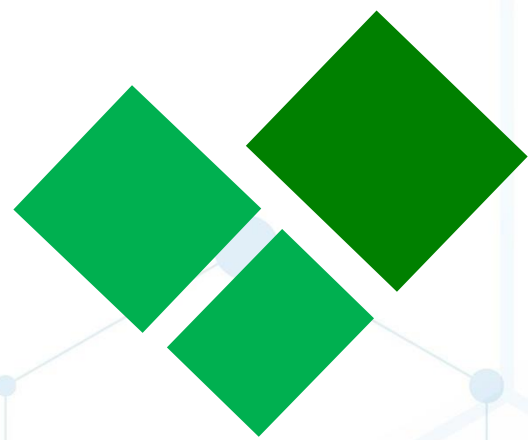

SPONSOR'S INFINITY BONUS – 50%

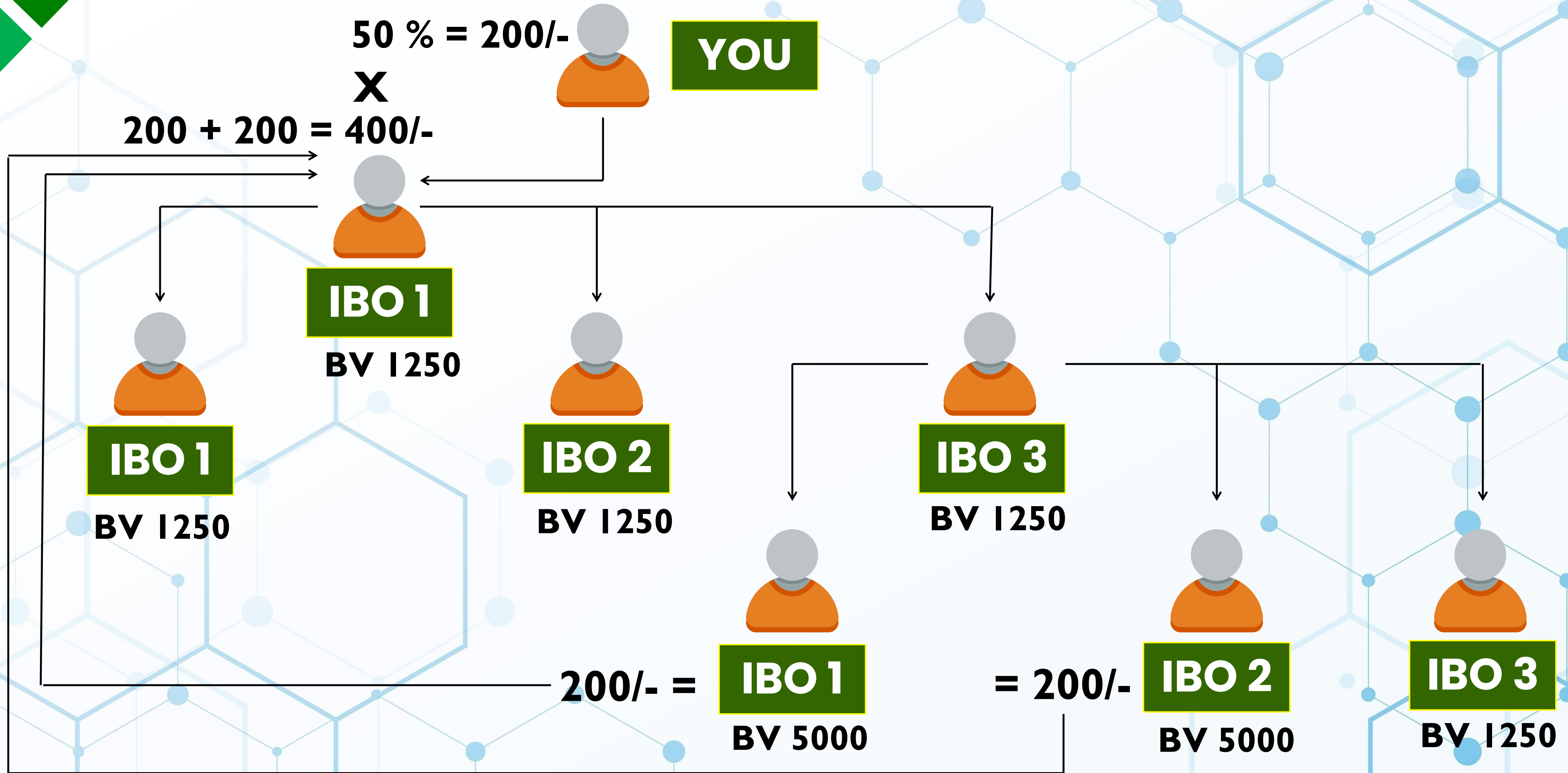

YOU You Will get 50% Infinity BONUS from each Direct Sponsor's like IBO 1 = 200/-

ROYALTY



ROYALTY BONUS

5%

Day once



CAR BONUS

5%
Day once

<https://www.triayurveda.com>



HOUSE BONUS

5%

Day once

<https://www.triayurveda.com>



TOUR & TRAVEL BONUS

5%
On Qualify

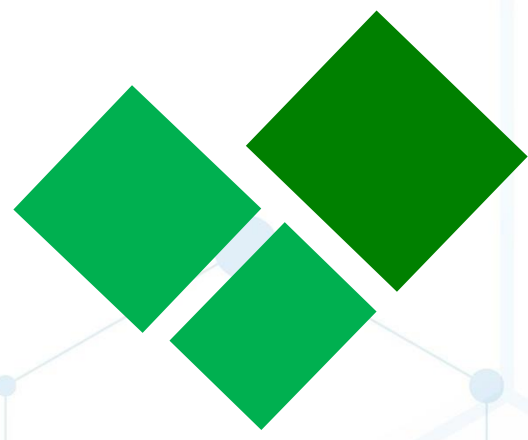

RANKS/REWARDS BONUS – 30%



Life Time

SR. NO.	RANK	BONUS	BONUS (ITEMS)
1.	BRONZE	750	WRIST WATCH
2.	SILVER	1500	LAPTOP BAG
3.	GOLD	3000	WHEEL TROLLY BAG
4.	PLATINUM	6000	MINI PROJECTOR
5.	EMERALD	12000	4G SMART PHONE
6.	RUBY	24000	LED 32 INCH + HOME THEATER
7.	SAPPHIRE	48000	BIKE (FINANCE)
8.	DIAMOND	96000	CAR (FINANCE)
9.	BLUE DIAMOND	192000	ROYAL ENFIELD
10.	BLACK DIAMOND	384000	CAR (EX-SHOWROOM PRICE)

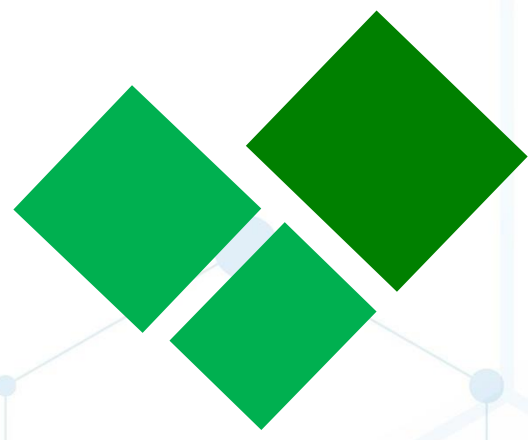

RANK/REWARDS BONUS – 30%



Life Time

SR. NO.	RANK	BONUS	BONUS (ITEMS)
11.	PURPLE DIAMOND	768000	CAR (FULL PAYMENT)
12.	RED DIAMOND	1536000	MEDIUM CAR (FINANCE)
13.	ROYAL DIAMOND	3072000	HOUSE/FLAT
14.	CROWN DIAMOND	6144000	AUDI / BMW
15.	AMBESSODOR	12288000	JAGUAR/ BANGLOW
16.	ROYAL AMBESSODOR	24576000	FARM HOUSE
17.	CROWN AMBESSODOR	49152000	HELICOPTER
18.	ROYAL CROWN AMBESSODOR	98304000	ROLLS ROYCE (FINANCE)
19.	TRIAYURVEDA TIGER	196608000	SHOPPING COMPLEX
20.	TRIAYURVEDA EAGLE	393216000	SHOPPING MALL

NOTE – 1. Reward will be given only NEXT BASIS. 2. ONE BONUS will be given only.

<https://www.triayurveda.com>

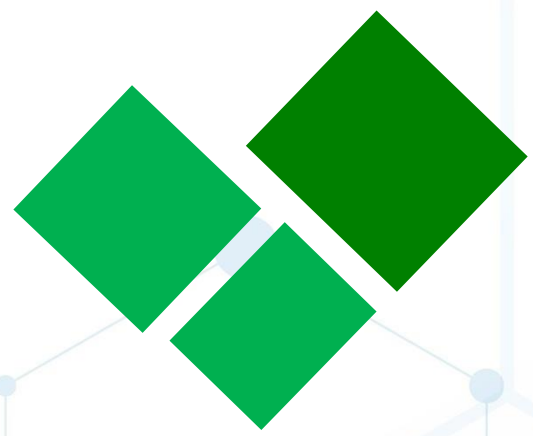

REPURCHASE RATIO BONUS – 10% (As BC1 & BC2 Ratio BONUS)

1. Per Day Capping will be same as **GROUP OF PRODUCTS.**
2. To get next month's weekly **BONUS**, repurchase must as given below-
 - A) **BONUS UPTO Rs. 799** (in a month) – No Repurchase
 - B) **BONUS from Rs. 800 to 3000** (in a month) - Repurchase of **Rs. 300**

Note - Repurchase onwards Multiple of every **BONUS Rs. 3000 X 10% = 300**

Example-

1. **BONUS Rs. 6000 X 10% = 600** (Repurchase)
2. **BONUS Rs. 9000 X 10% = 900** (Repurchase)
3. **BONUS UPTO Rs. 99000 X 10% = 9900** (Repurchase)
4. **BONUS onwards above Rs. 100000 X 10% = 10000** (Repurchase) till unlimited **BONUS.**

Note – You have to Repurchase product from 1st to 6th date of month in Single Invoice.

<https://www.triayurveda.com>

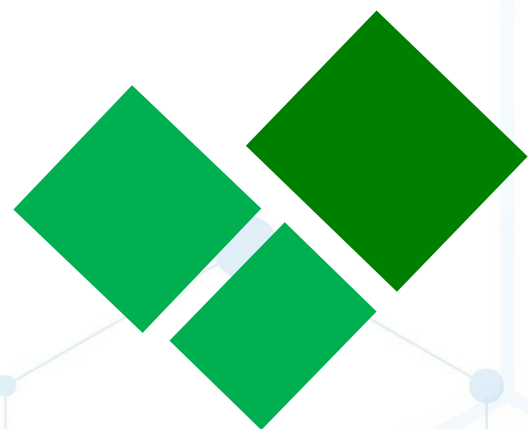

FRANCHISE MODEL – 20%



COMPANY

FRANCHISE BONUS 14%

FRANCHISE REFFRAL BONUS 6%

**STATE FRANCHISE Rs. 25 Lac
BONUS - 14%
FRANCHISE RAFFRAL - 4%**

**IBO
1%**

**DISTRICT FRANCHISE Rs. 5 Lac
BONUS - 10%
FRANCHISE RAFFRAL - 4%**

**IBO
2%**

**MOBILE FRANCHISE Rs. 1 Lac
BONUS - 6%**

**IBO
3%**

Note – 1.) All BONUS on BV Basis. 2.) Transport Expense Bearing by Franchise Holder.
3.) BONUS will be released next month, Date 1st to 5th. 4.) Franchise Agreement According To Term & Conditions.

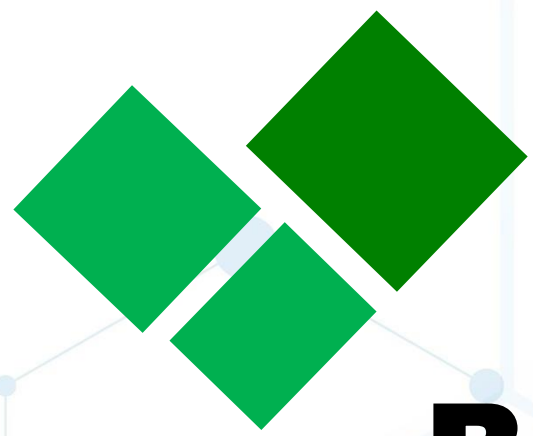

OUR BANKER'S



Bank Name -

INDUSIND BANK

**IndusInd
Bank**



Account Holder Name -

**TRIAYURVEDA HEALTHTRADE
PRIVATE LIMITED**

TRIAYURVEDA HEALTHTRADE

Account Number -

251110222468



IFS Code-

INDB0000750



<https://www.triayurveda.com>

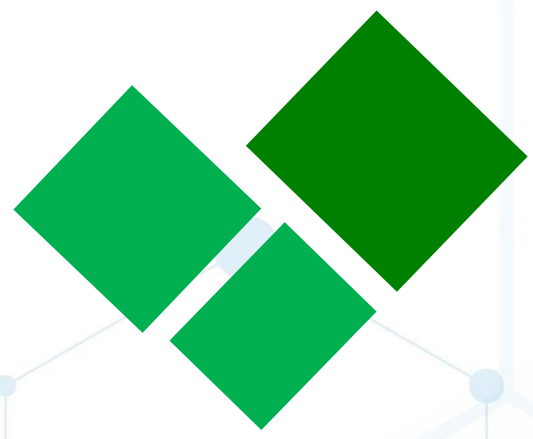

TERMS & CONDITIONS

- ❖ **Business Volume will not be HOLD in inactive IBO's.**
- ❖ **To increase per day capping, Top Up will be in single invoice from 8th to 28th date of month.**
- ❖ **Two IBO's must Sponsor one in BC 1 & one in BC 2.**
- ❖ **TDS – 5 % (If PAN No. not Updated in IBO's ID, TDS Deduction 20% Applicable)**
- ❖ **Admin – 10 %**
- ❖ **Daily Closing of Business Volume.**
- ❖ **Minimum Weekly Payout – Rs. 100/- and above.**
- ❖ **Weekly payout closing on 7th , 14th , 21st & 28th Date of month & Payout will be released with in next 3 days.**
- ❖ **Trimming applicable.**
- ❖ **Courier Free Above – 1250 Business Volume.**

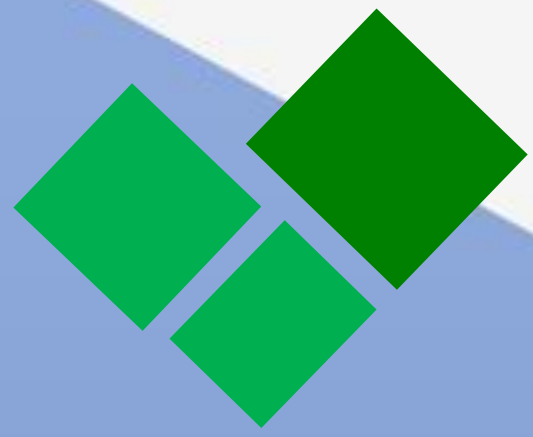

VISIT US

**TRIAYURVEDA™**



**KALLI PASCHIM NEAR SGPGI
RAIBARELY ROAD LUCKNOW
PIN CODE - 226301**



**<https://www.triayurveda.com>
Click Link (To open Website)**



support@triayurveda.com





TRIAYURVEDATM

Thank you!!